

NS-30-K

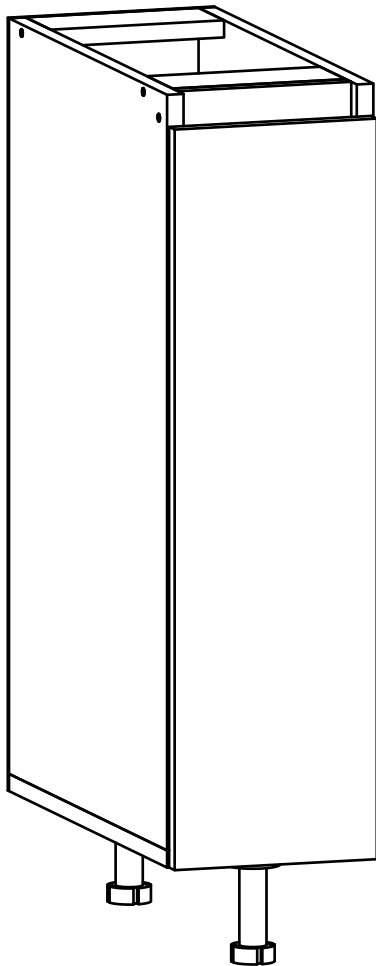

Д-300, Ш-474, В-820, мм.

L-300, W-474, H-820, mm.

Інструкція збірки
Assembly instruction

1

«NS-30-K»

№	довжина(мм) length(mm)	ширина(мм) width(mm)	кількість quantity											
1	704*	458	1											
2	704*	458	1											
3	458**	300*	1											
4	268*	74	5	268**	50	1	6	688**	294**	1	7	718	298	1
5	268**	50	1											
6	688**	294**	1											
7	718	298	1											

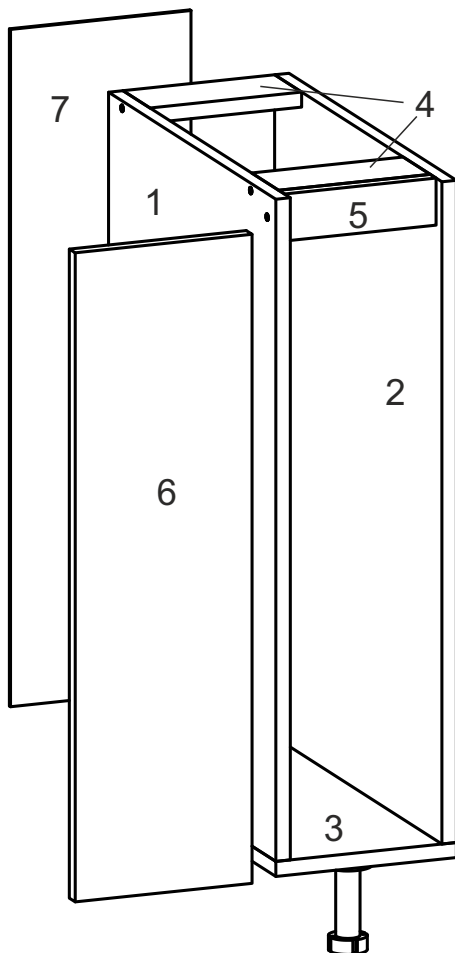
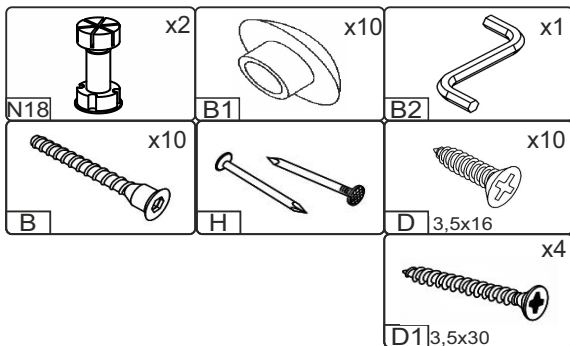

1.

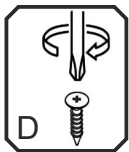
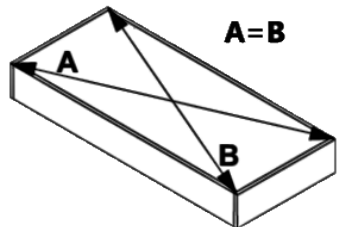
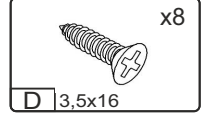
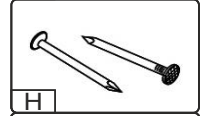
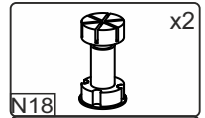
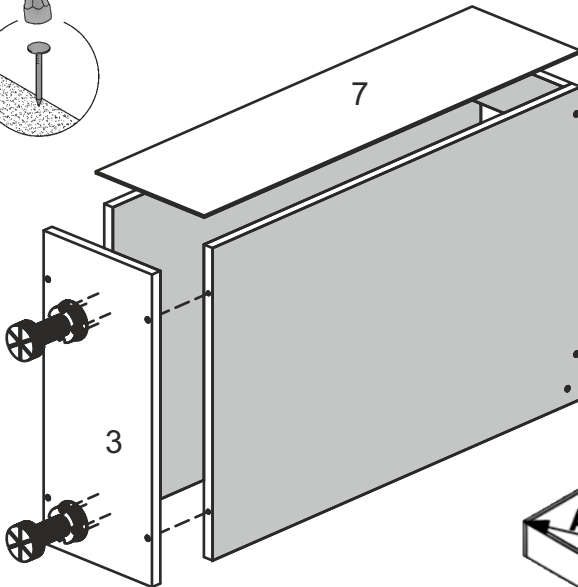
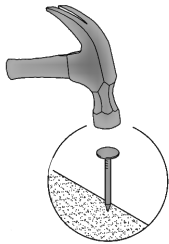
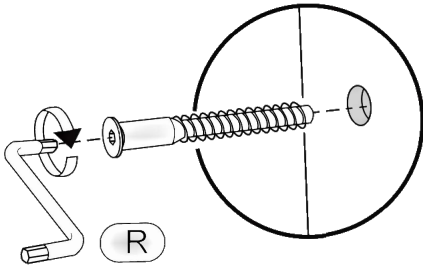
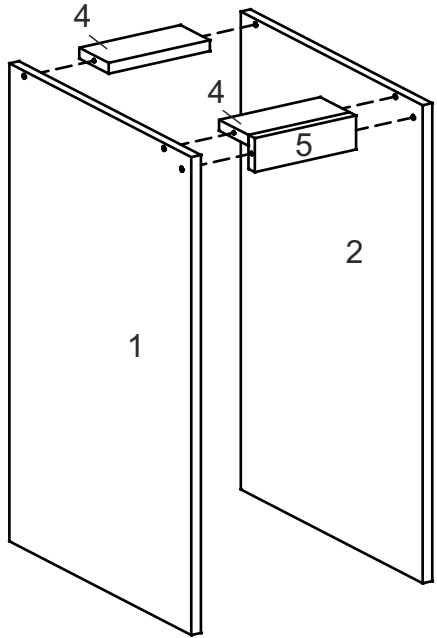
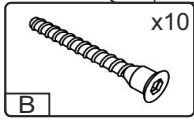
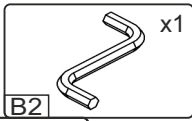

3

