

NS-20-K

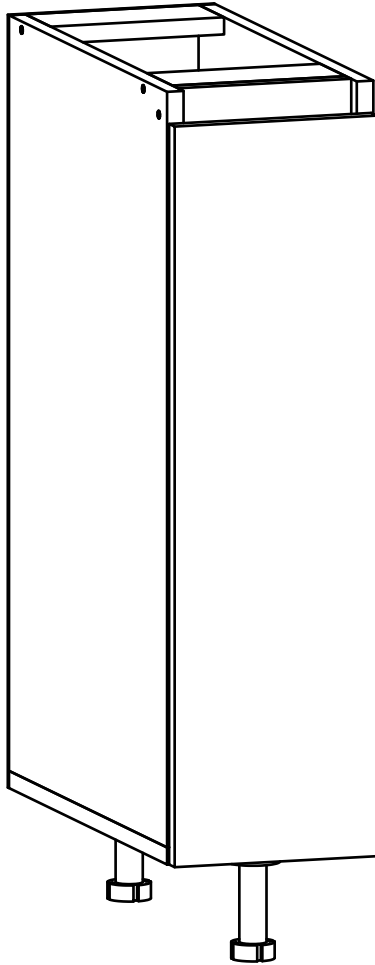

Д-200, Ш-474, В-820, мм.

L-200, W-474, H-820, mm.

Інструкція збірки
Assembly instruction

1

«NS-20-K»

№	довжина(мм) length(mm)	ширина(мм) width(mm)	кількість quantity											
1	704*	458	1											
2	704*	458	1											
3	458**	200*	1											
4	168*	74	5	168**	50	1	6	688**	194**	1	7	718	198	1
5	168**	50	1											
6	688**	194**	1											
7	718	198	1											

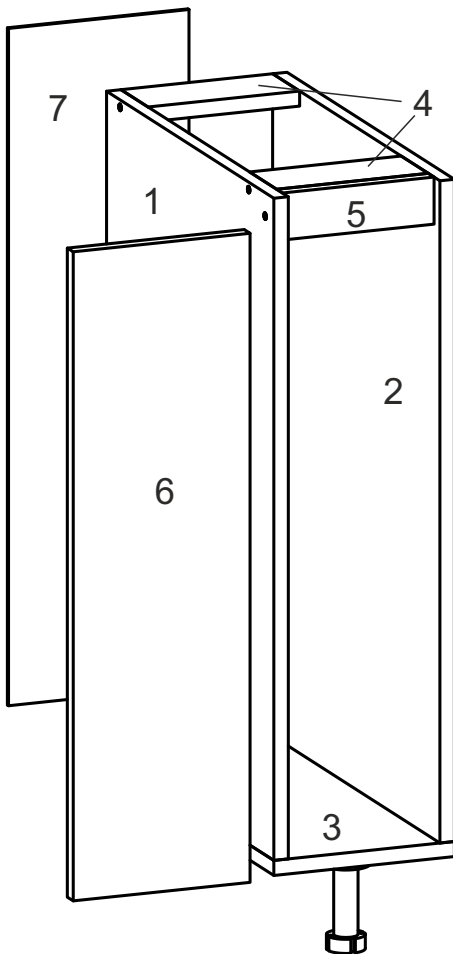
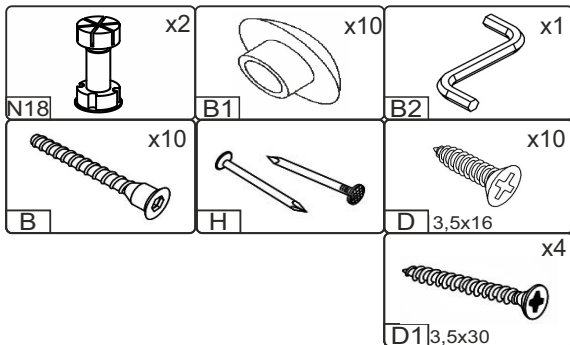

1.

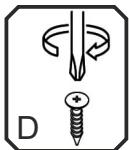
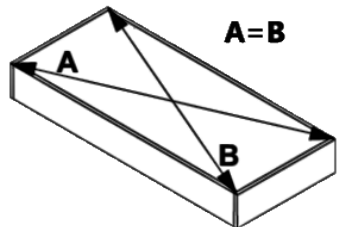
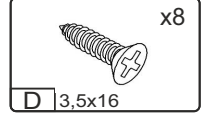
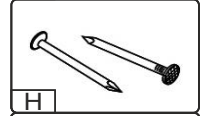
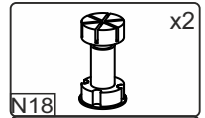
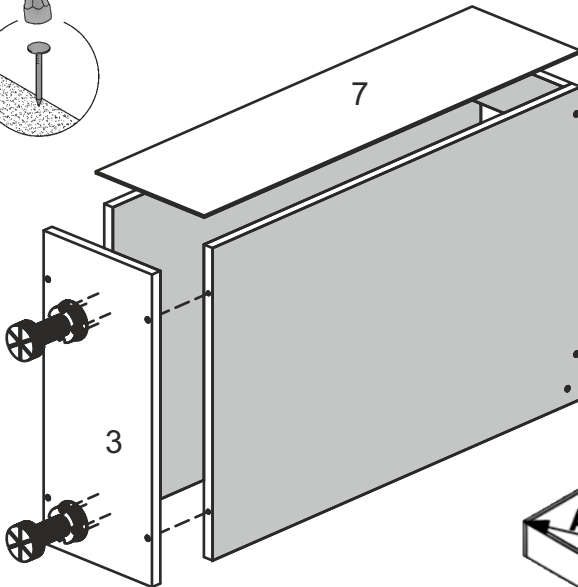
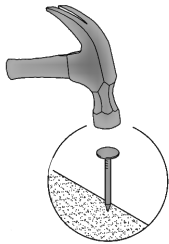
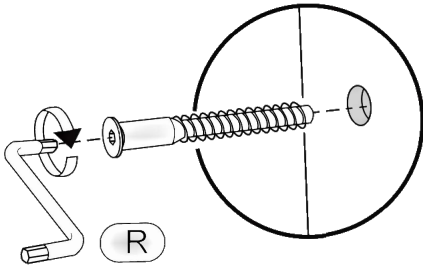
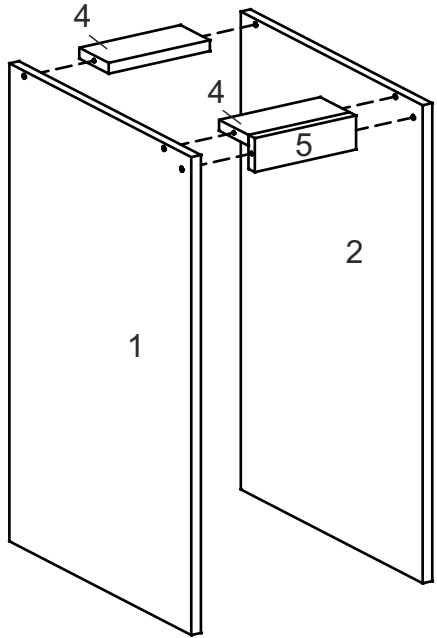
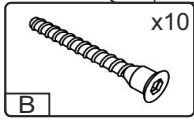
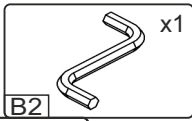

3

