

Зроблено в Україні ТМ «Pehotin»
Made in Ukraine by «Pehotin»

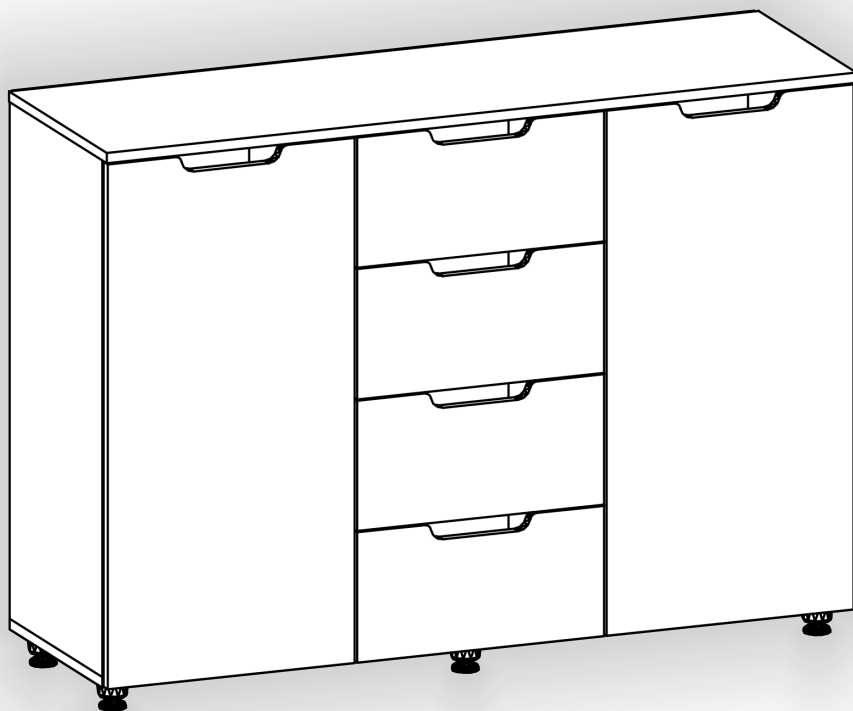

Комод «К-4+2 ЕКО»
Dresser «K-4+2 ECO»



Д-1200, Ш-380, В-868, мм.
L-1200, W-380, H-868, mm.

Інструкція збірки
Assembly instruction

1



pehotin@gmail.com
pehotin.com.ua

«К-4+2 ЕКО»/«К-4+2 ECO»

№	довжина(мм) length(mm)	ширина(мм) width(mm)	кількість quantity
1	1202*	380**	1
2	1200*	360**	1
3	794*	360	1
4	794*	360	1
5	794*	360	1
6	794*	360	1
7	340	355	4
8	344*	100	4
9	384*	350	2
10	820	405	2
11	820	384	1
12	806**	396**	1
13	806**	396**	1

№	довжина(мм) length(mm)	ширина(мм) width(mm)	кількість quantity
14	198**	396**	4
15	334*	100	8

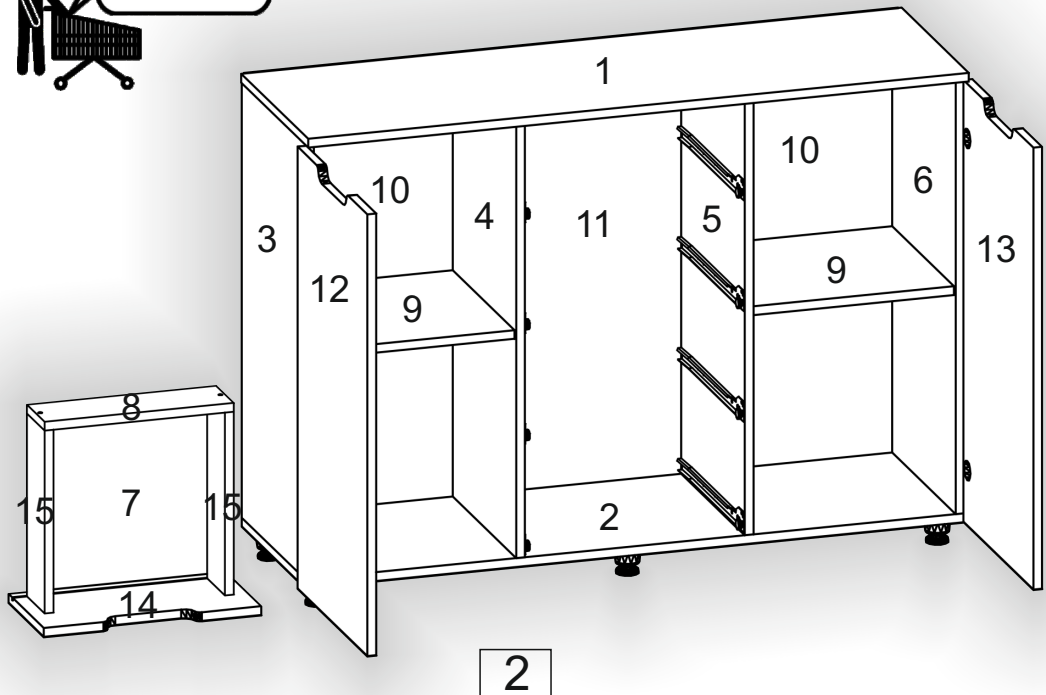
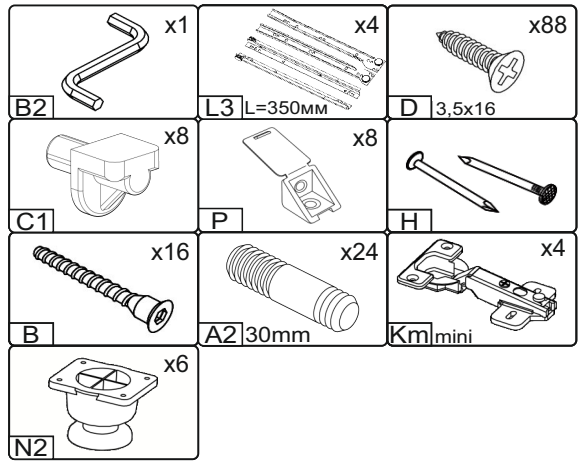

1.

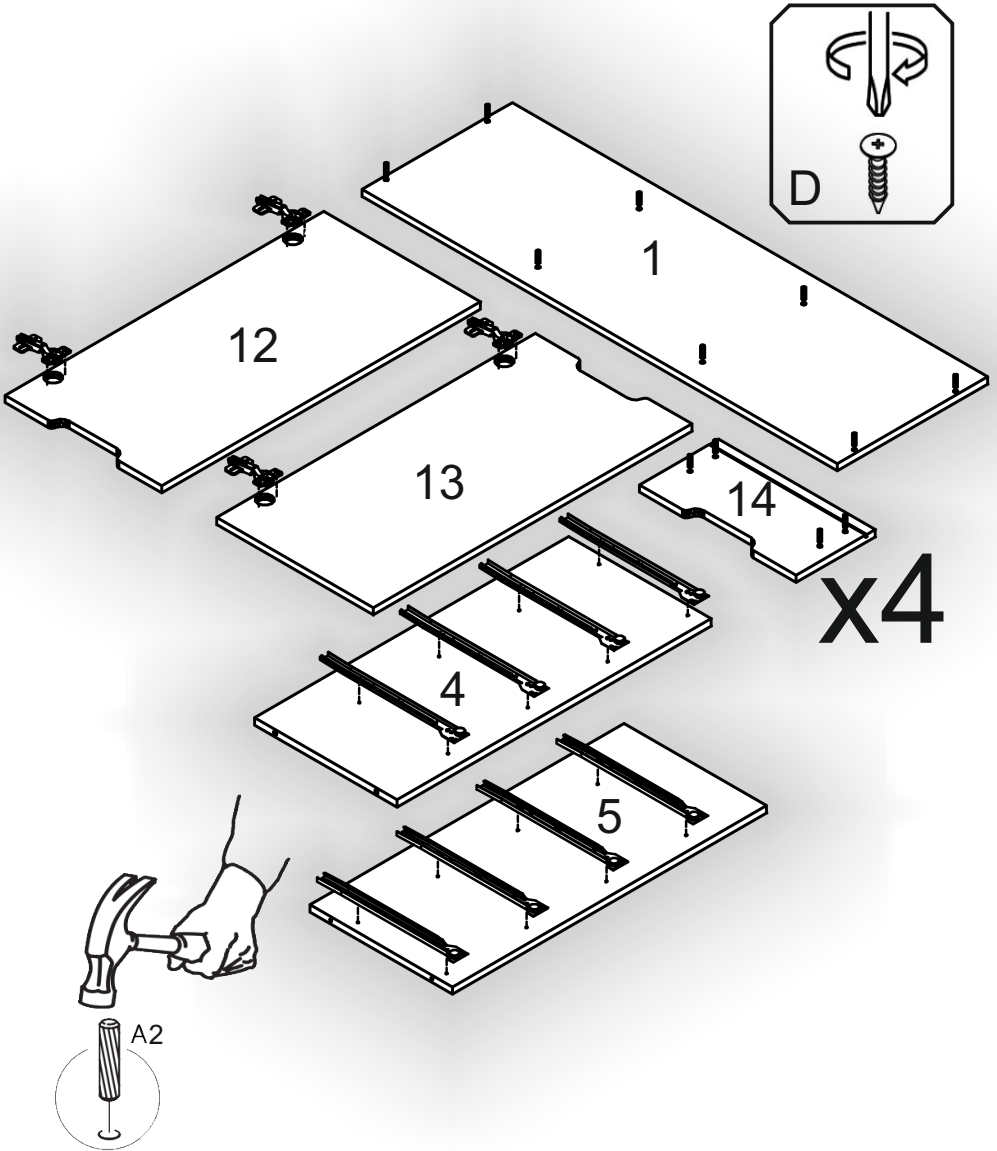
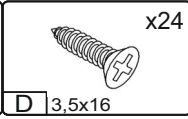
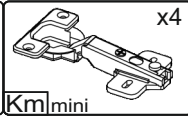
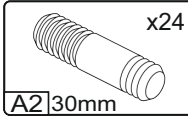

3

2.

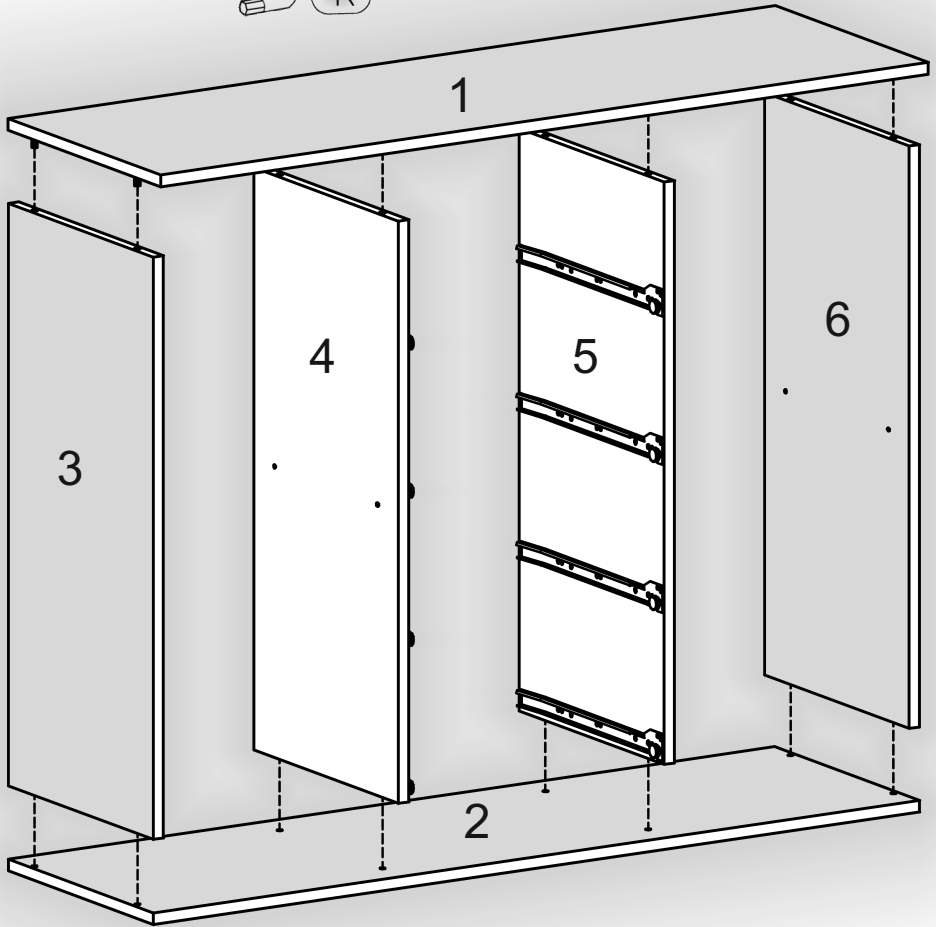
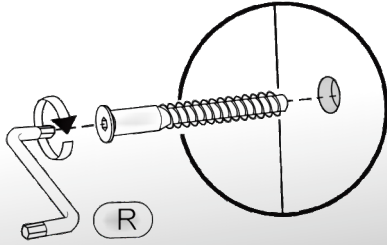
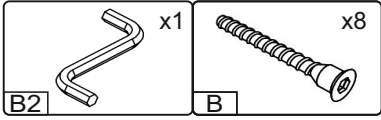

3.

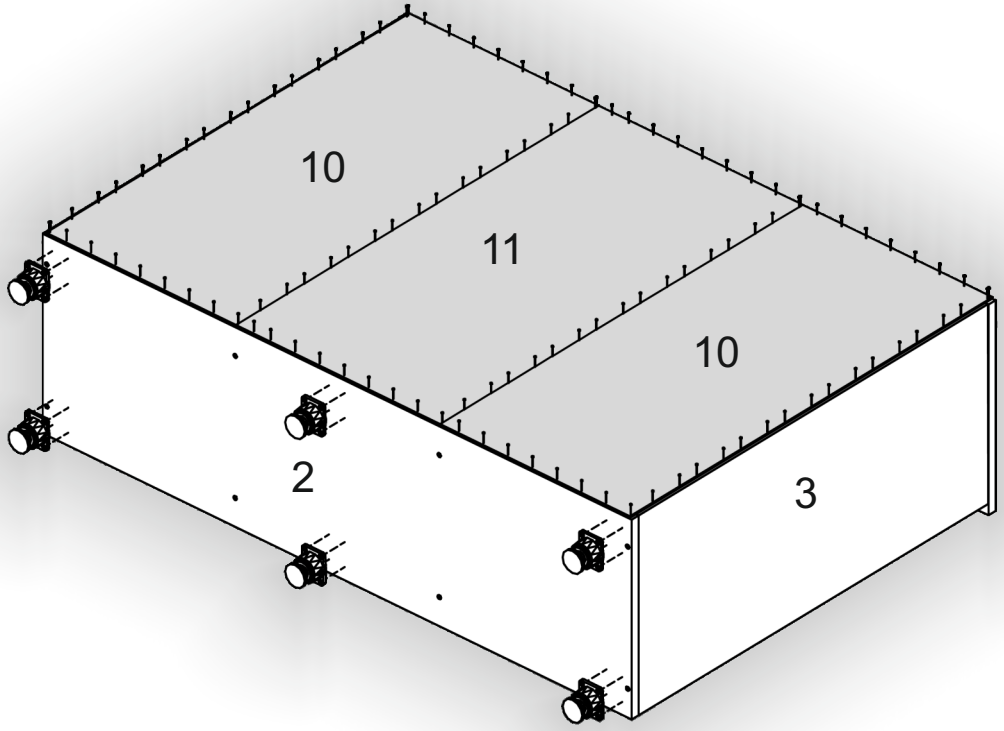
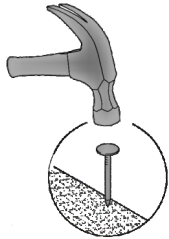
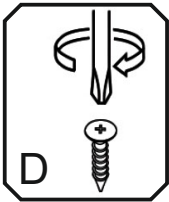
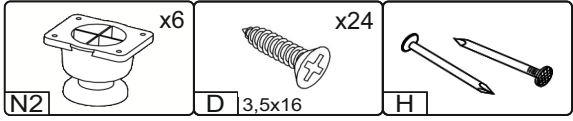



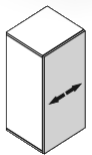
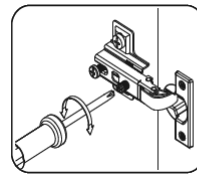
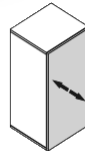
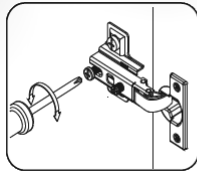
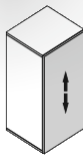
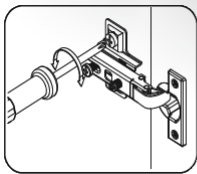
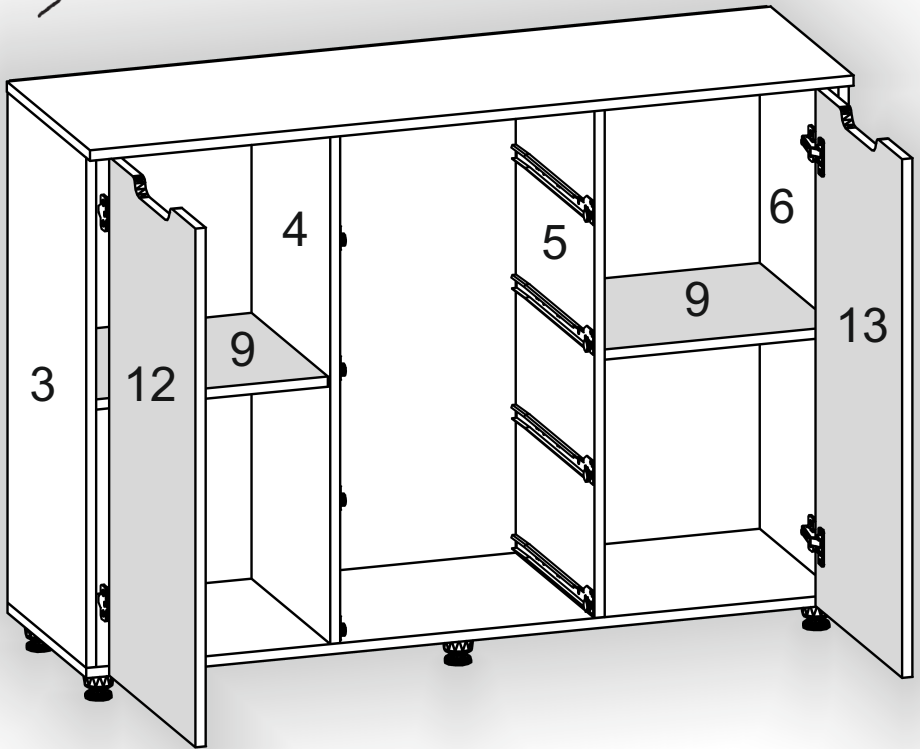
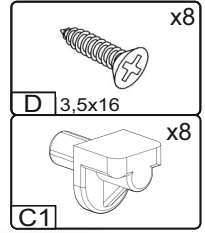
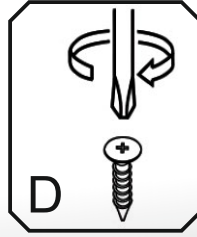
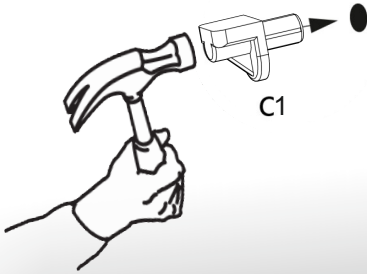



4.

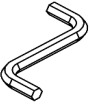

6

5. x4

- | | | | |
|---|--|---|---|
|  x1 |  x8 |  x8 |  x32 |
| B2 | P | B | D 3,5x16 |
|  H |  x4
L3 L=350MM | | |

