

E-60-VO

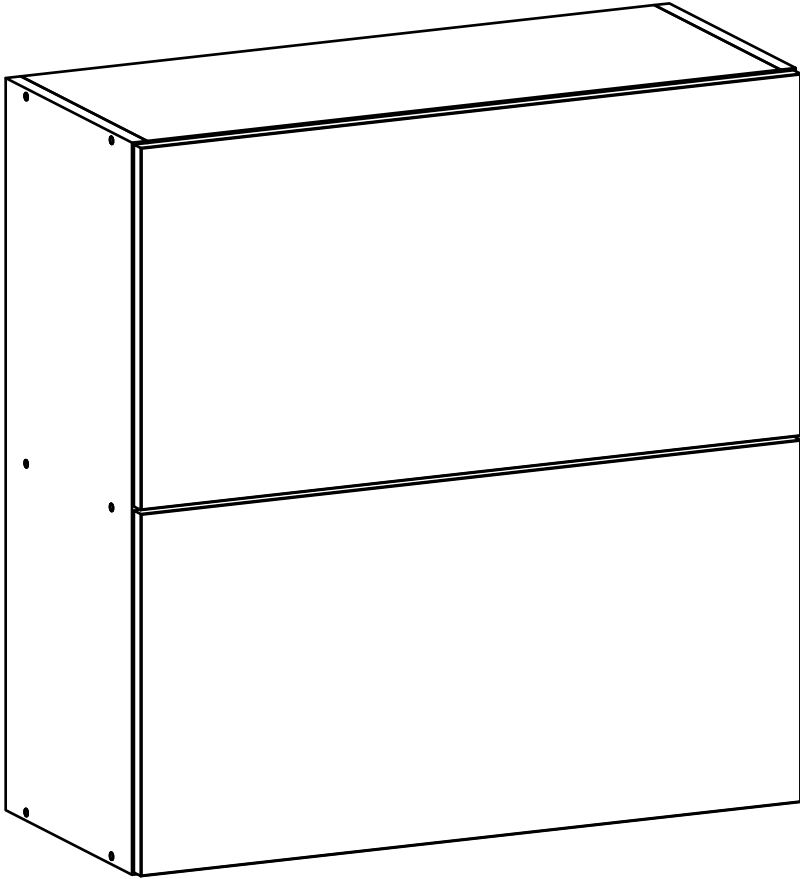

Д-600, Ш-320, В-720, мм.

L-600, W-320, H-720, mm.

Інструкція збірки
Assembly instruction

1

E-60-VO

№	довжина(мм) length(mm)	ширина(мм) width(mm)	кількість quantity
1.	568*	300	1
2.	568*	300	1
3.	720*	300**	1
4.	720*	300**	1
5.	568*	286	1
6.	594**	353**	2
7.	580	357	1
8.	580	341	1

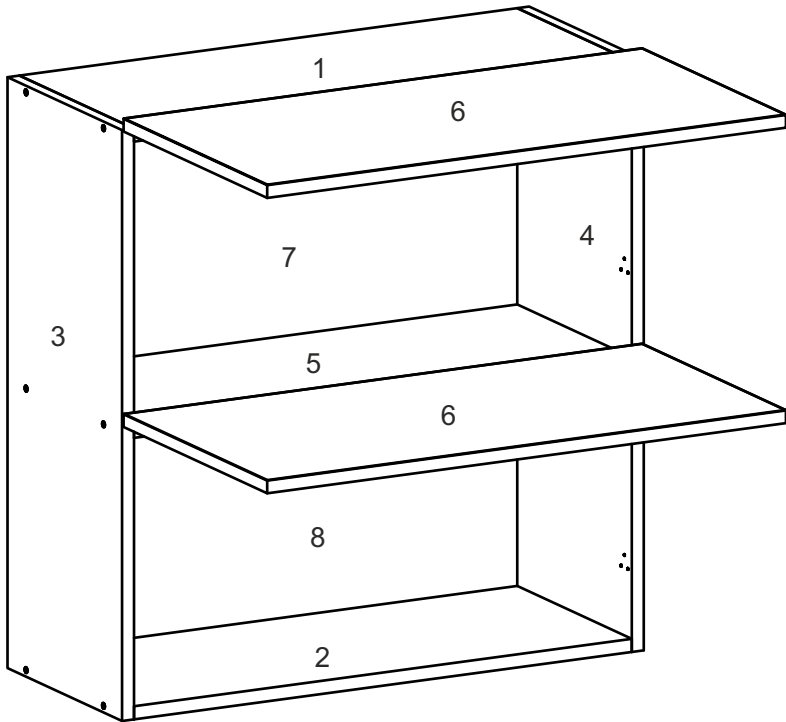
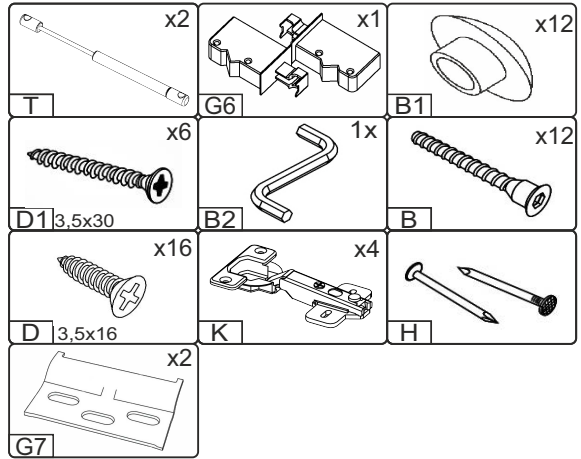

Важливо! Перед свердлінням отворів переконайтеся, що правильно обрали розташування ручок, і використовуйте відповідний інструмент.

Important! Before drilling holes, make sure you have chosen the correct handle placement and use the appropriate tools.

1.

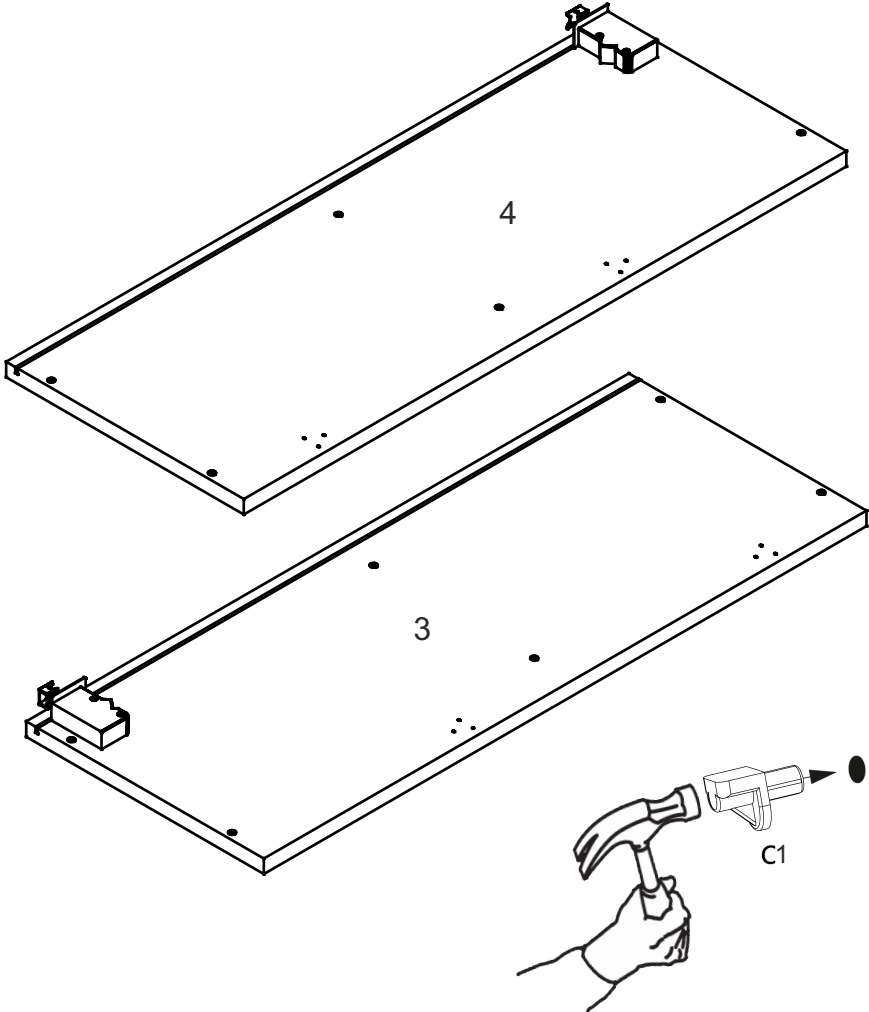
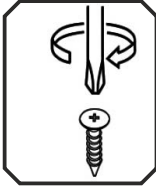
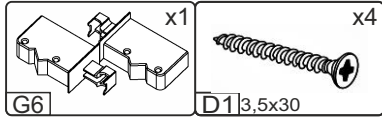

3

2.

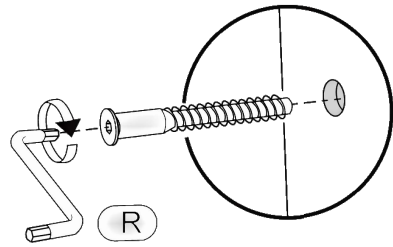
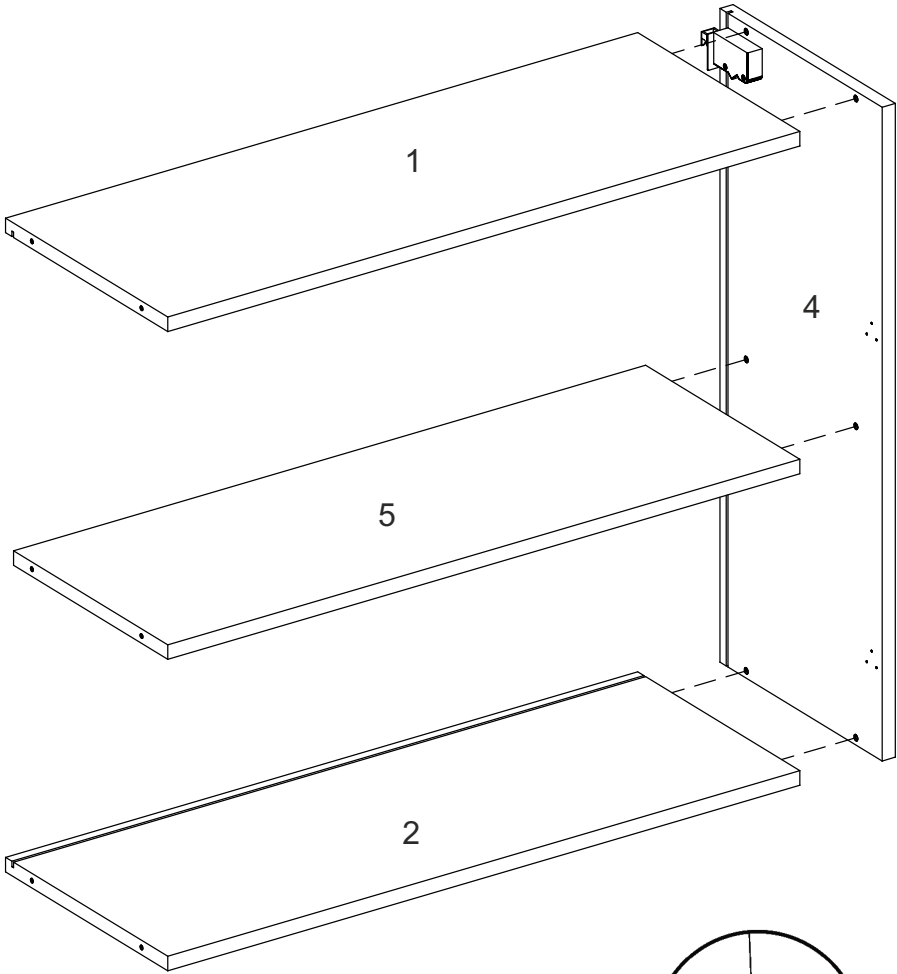
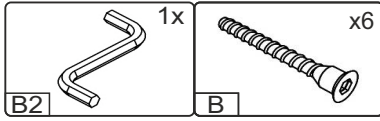

3.

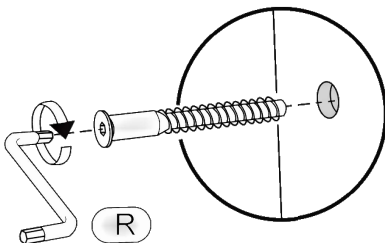
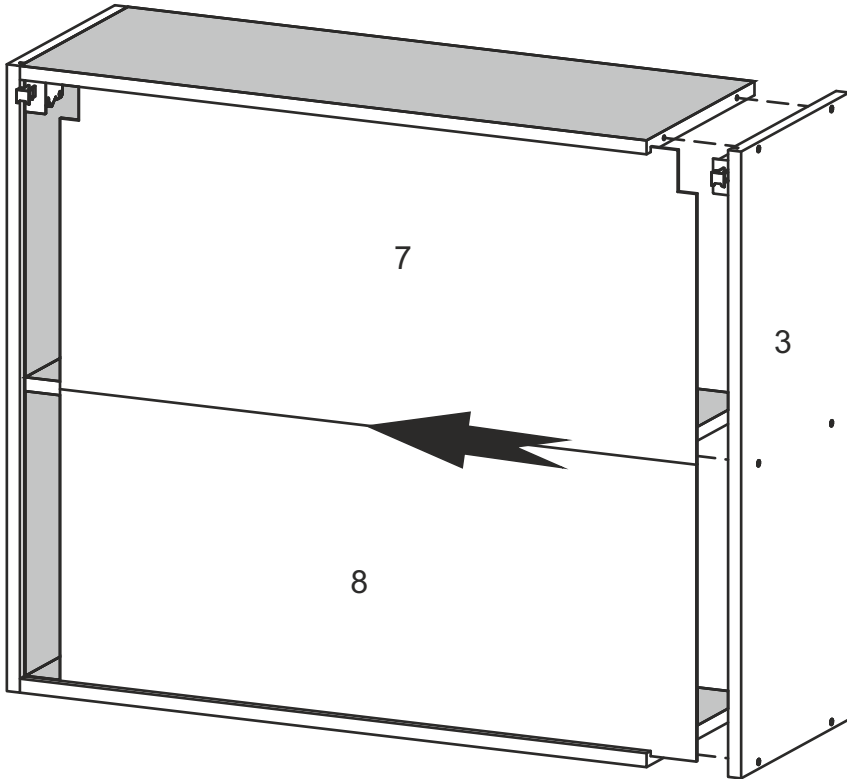
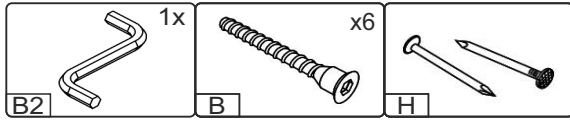

5

4.

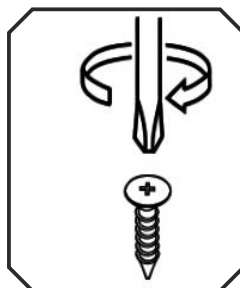
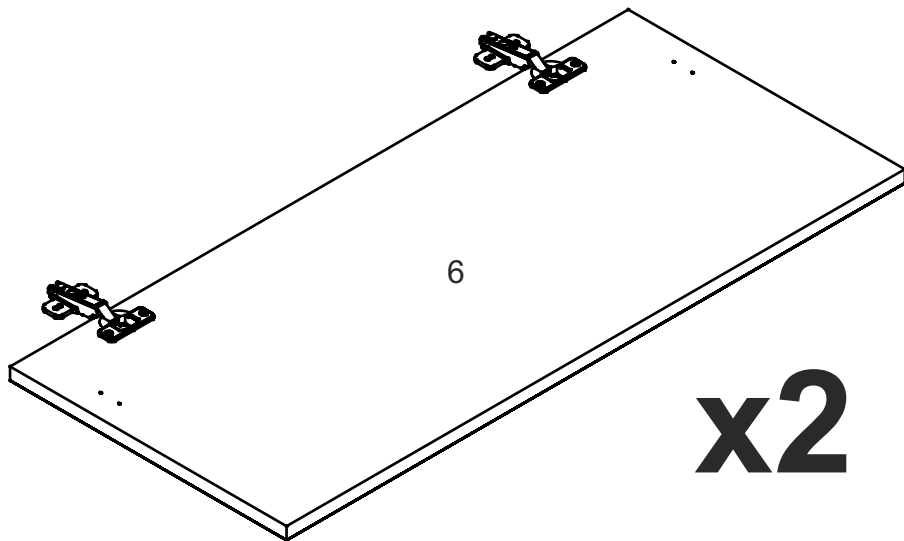
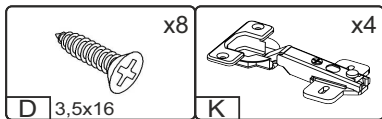

6

4.

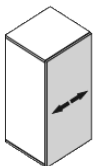
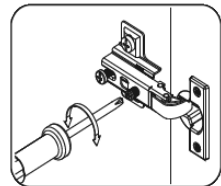
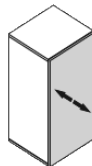
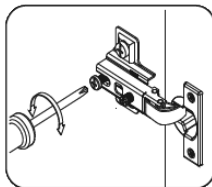
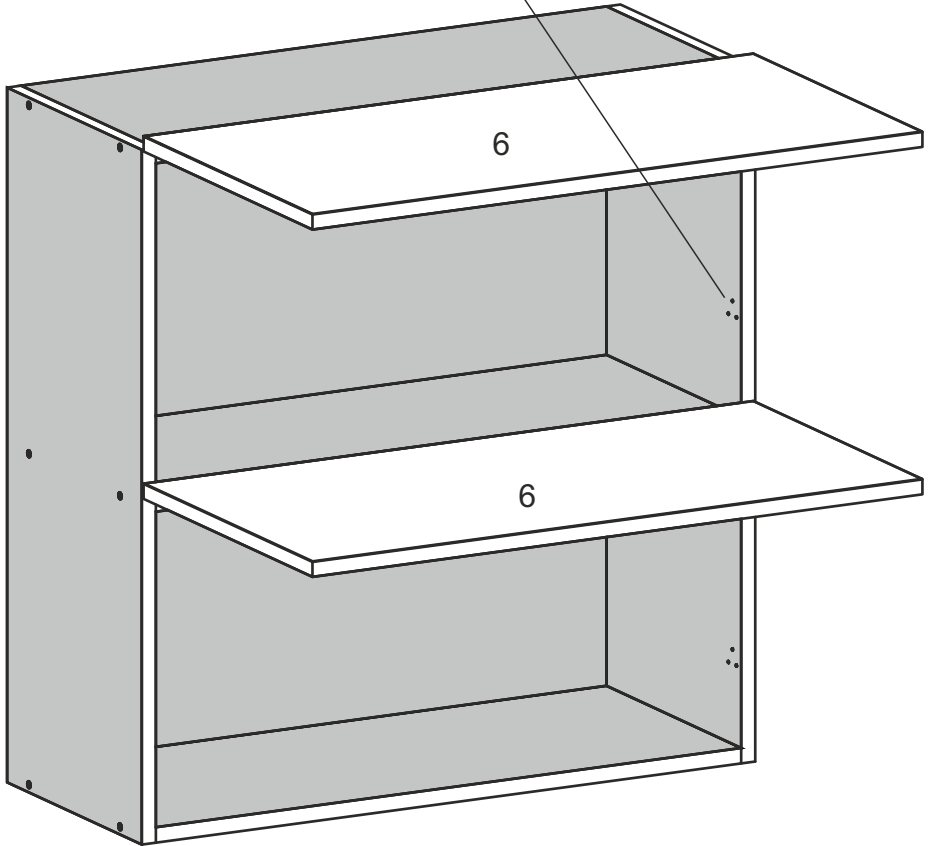
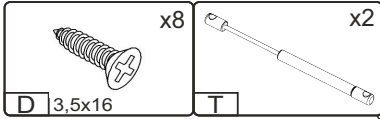

7

