

E-40-V

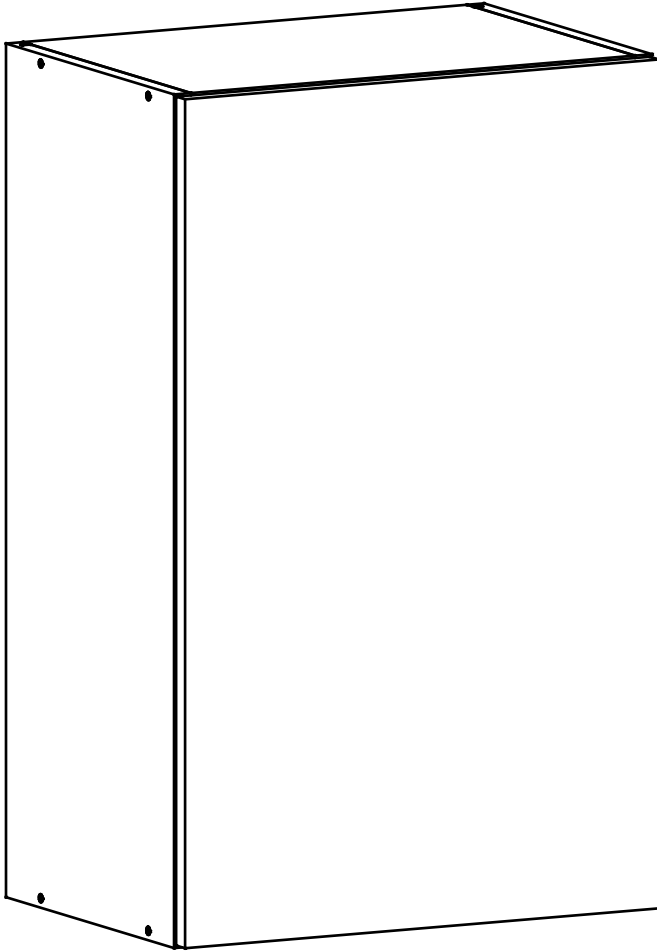

Д-400, Ш-320, В-720, мм.

L-400, W-320, H-720, mm.

Інструкція збірки
Assembly instruction

1

E-40-V

№	довжина(мм) length(mm)	ширина(мм) width(mm)	кількість quantity
1.	368*	300	2
2.	368*	268	1
3.	713**	394**	1
4.	720*	300**	2
5.	700	380	1

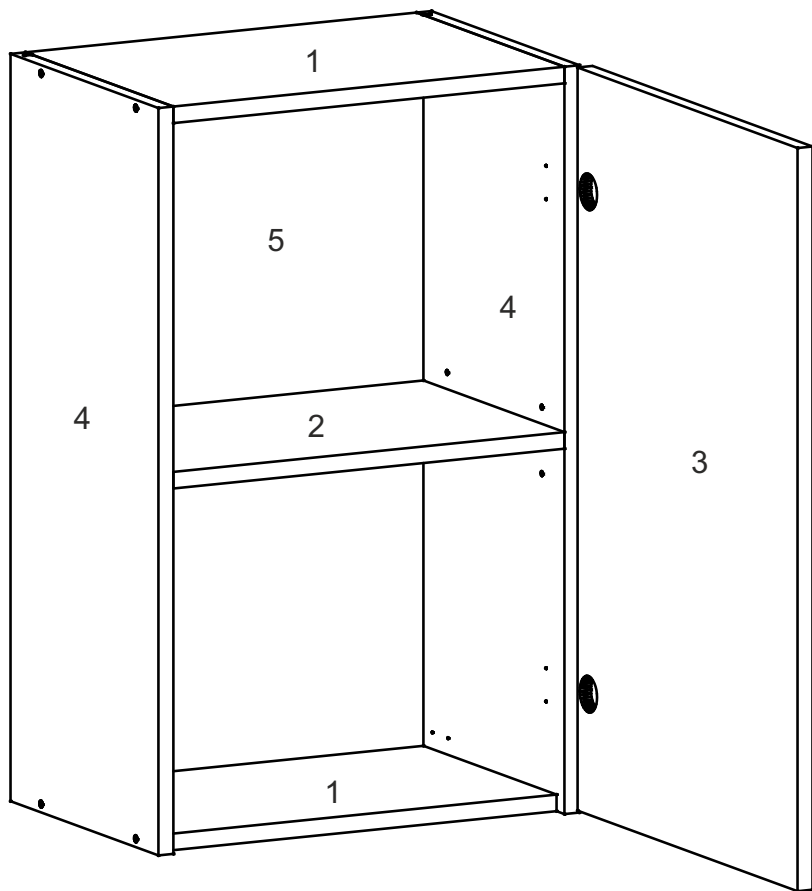
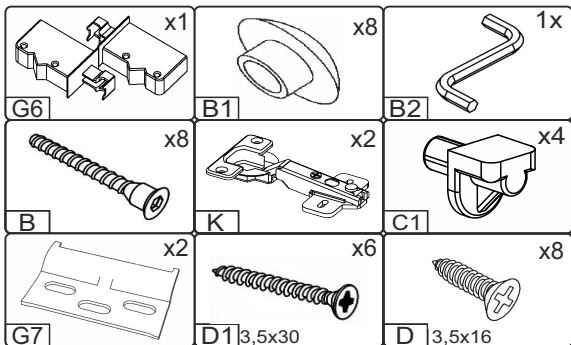

Важливо! Перед свердлінням отворів переконайтеся, що правильно обрали розташування ручок, і використовуйте відповідний інструмент.

Important! Before drilling holes, make sure you have chosen the correct handle placement and use the appropriate tools.

1.

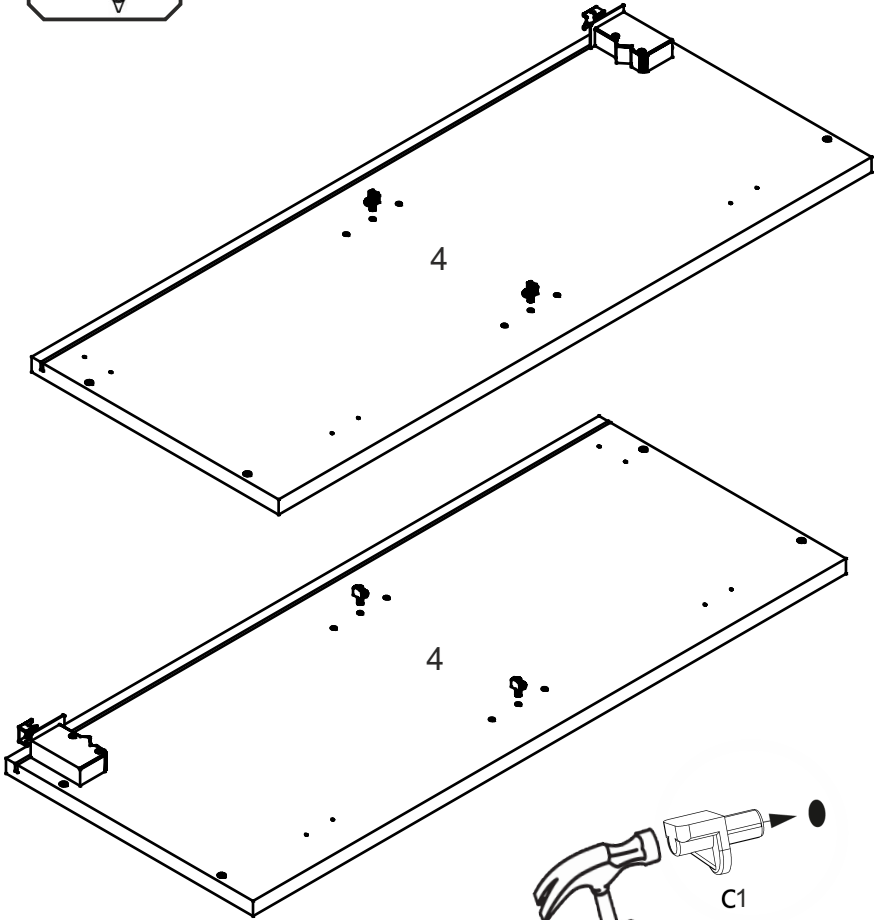
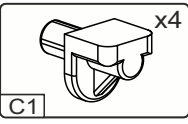
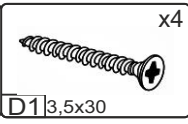
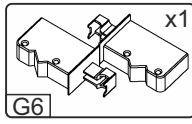

3

2.

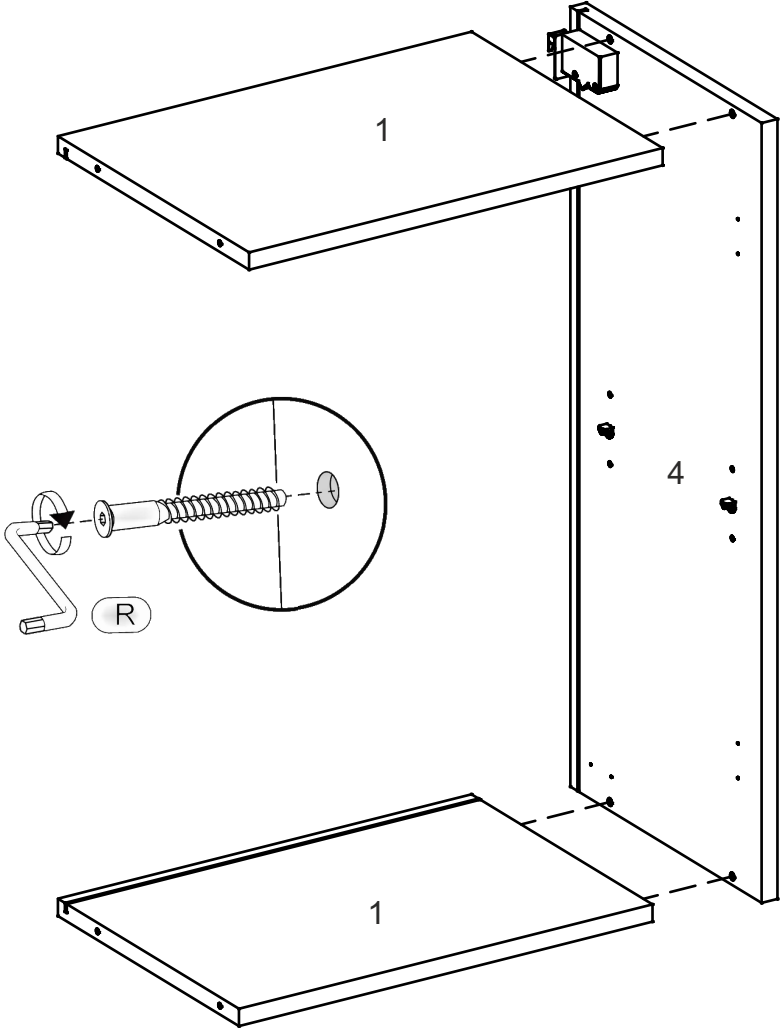
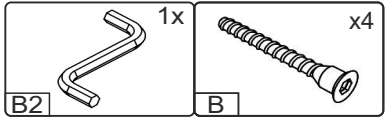

3.

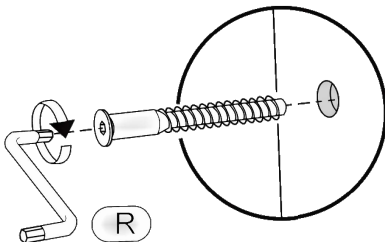
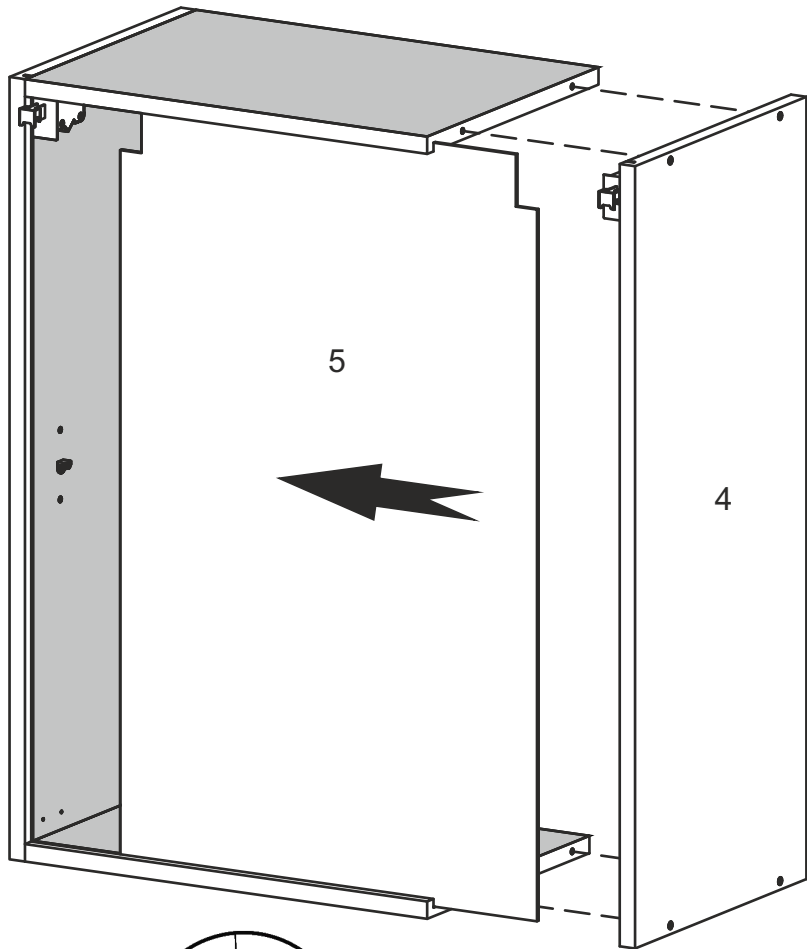
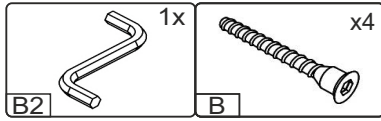

5

4.

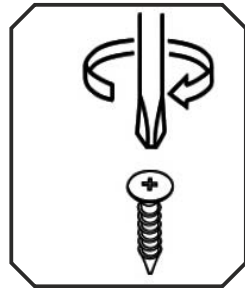
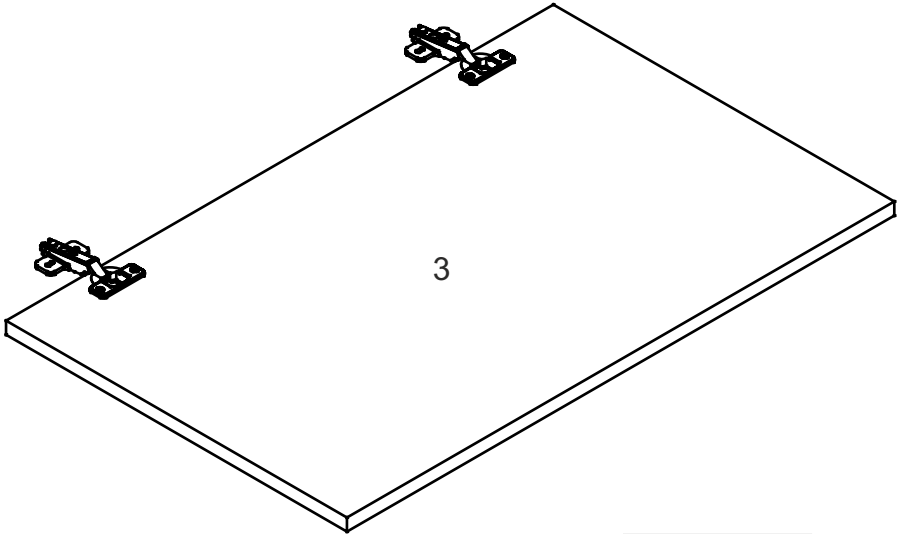
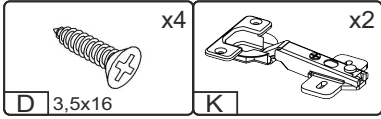

4.

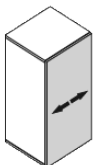
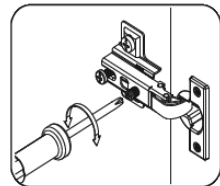
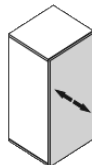
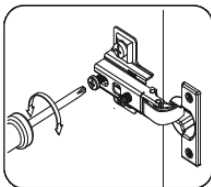
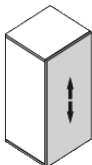
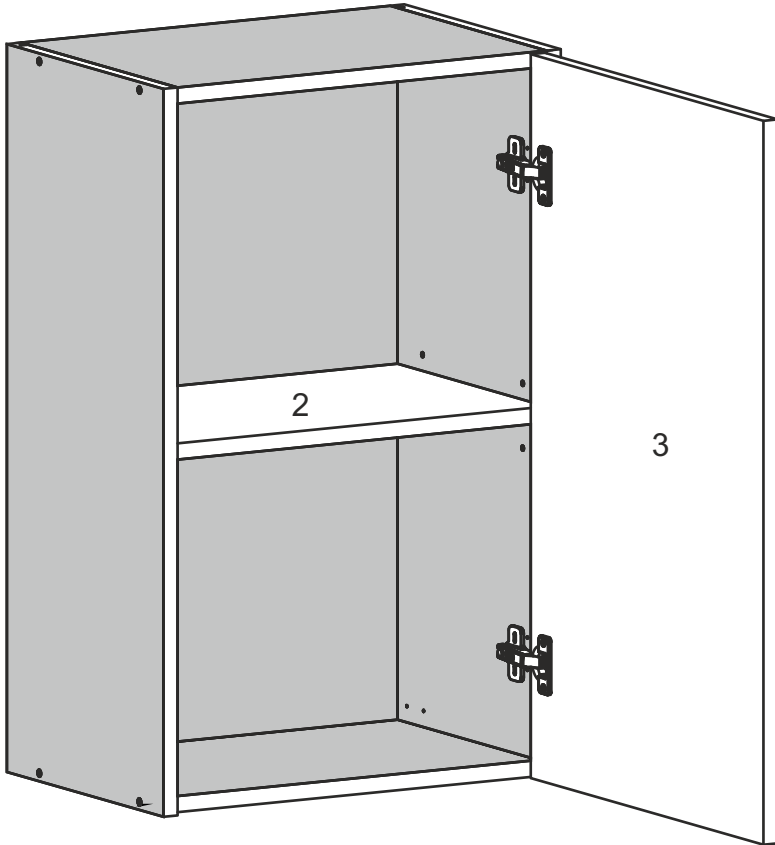
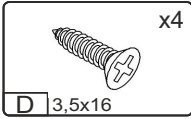

7

