

E-30-K

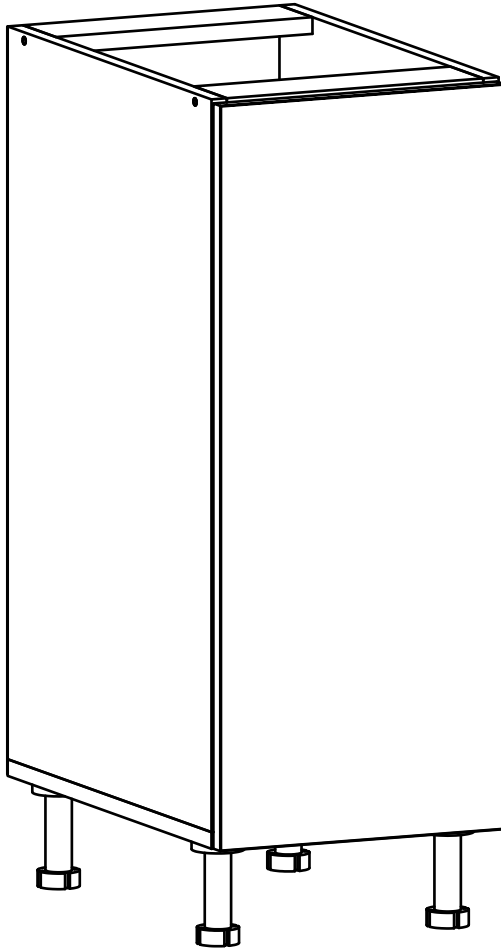

Д-300, Ш-474, В-820, мм.

L-300, W-474, H-820, mm.

Інструкція збірки
Assembly instruction

1

«E-30-K»

№	довжина(мм) length(mm)	ширина(мм) width(mm)	кількість quantity
1	704*	458	1
2	704*	458	1
3	458**	300*	1
4	268*	74	2
5	713**	294**	1
6	718	298	1

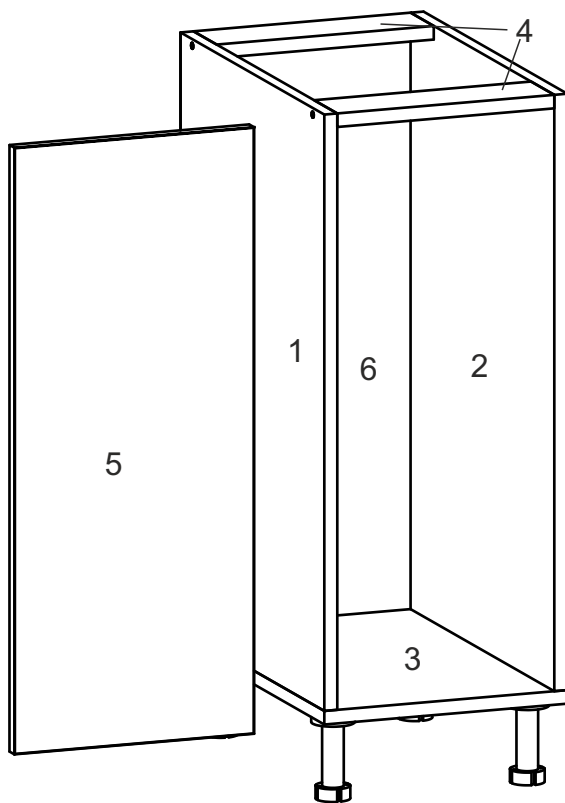
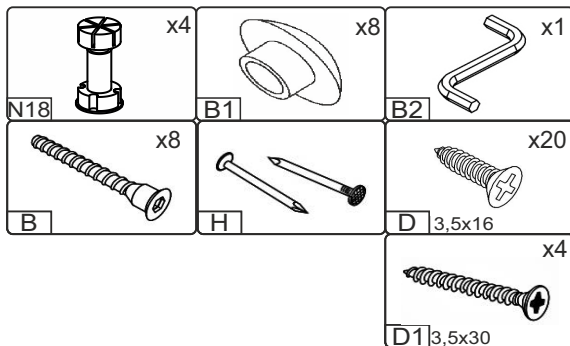

Важливо! Перед свердлінням отворів переконайтеся, що правильно обрали розташування ручок, і використовуйте відповідний інструмент.

Important! Before drilling holes, make sure you have chosen the correct handle placement and use the appropriate tools.

1.

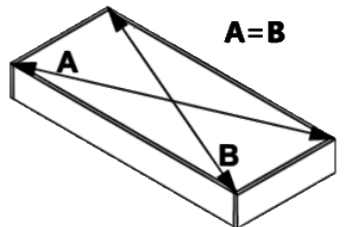
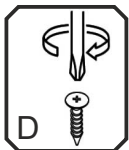
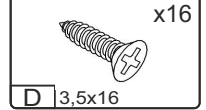
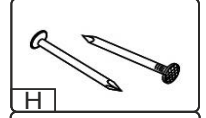
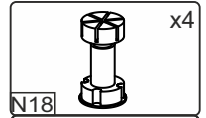
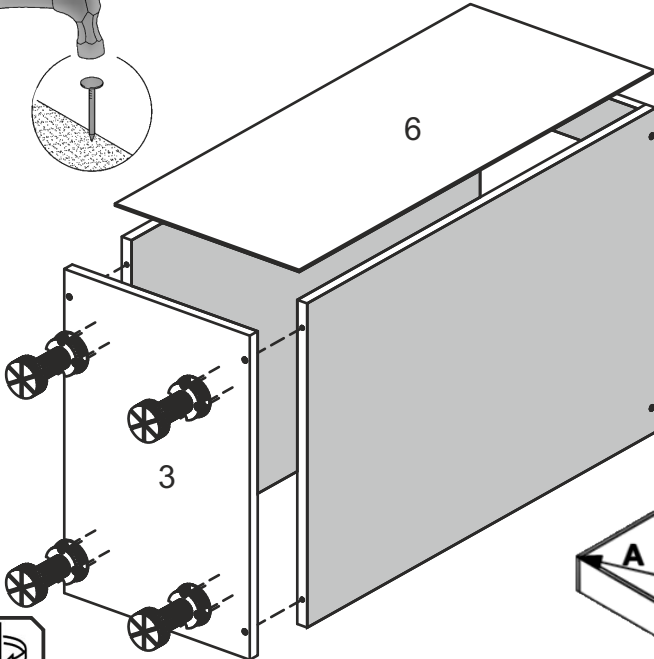
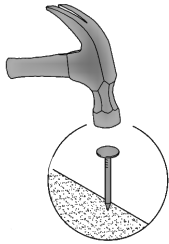
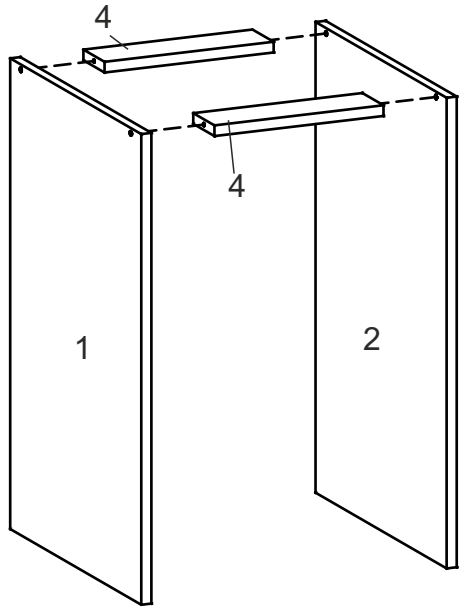
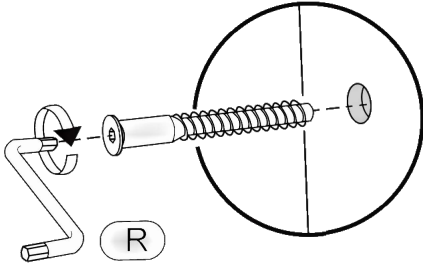
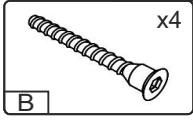
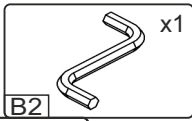

3

