

# 15-0V

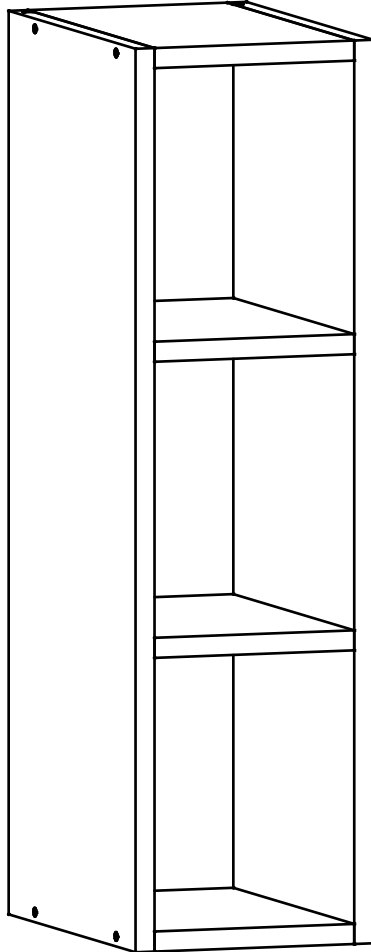

Д-150, Ш-300, В-720, мм.

L-150, W-300, H-720, mm.

Інструкція збірки  
Assembly instruction

1

15-OV

№	довжина(мм) length(mm)	ширина(мм) width(mm)	кількість quantity
1.	720*	300**	2
2.	118**	300	2
3.	118*	268	2
4.	700	130	1

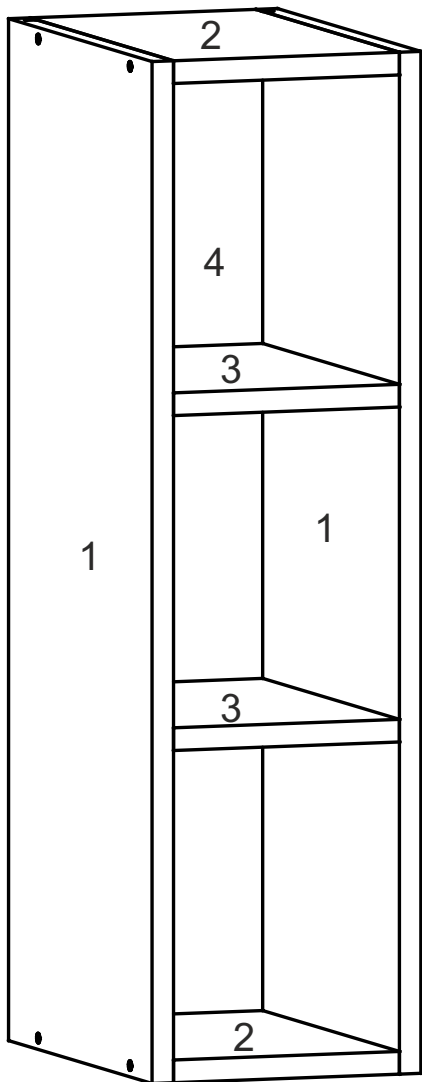
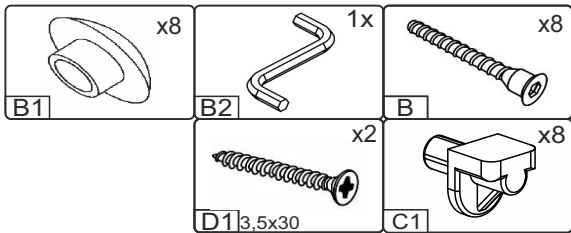

1.

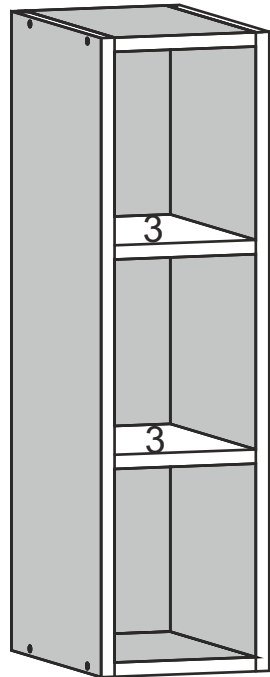
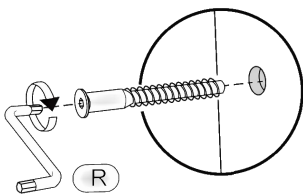
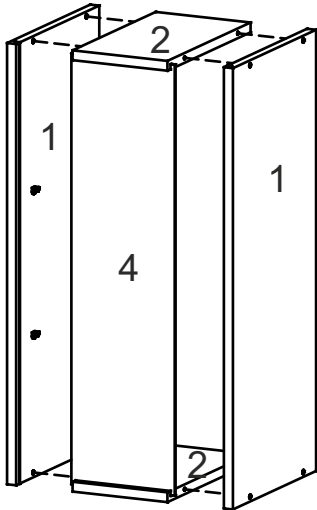
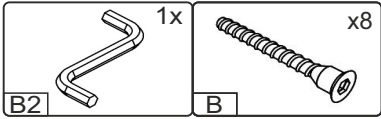
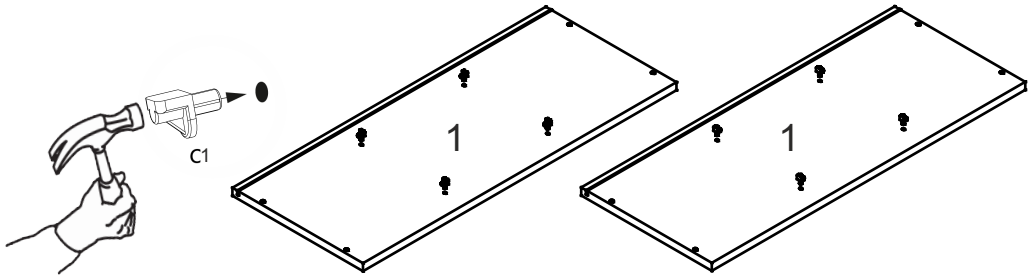
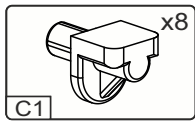

3

